

MEMORIAL INSTALLATION (memorial chamber located at top of candle)

1

Grasp candle body firmly with one hand and grasp Memorial Chamber lid with the other.

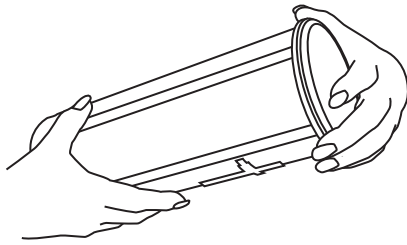

FIG. 1

4

Place Memorial item in the chamber

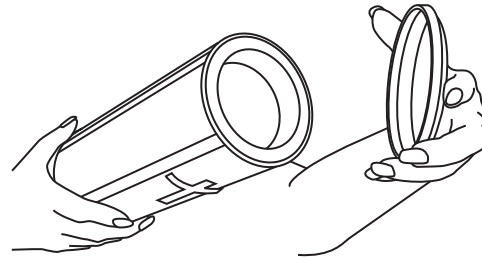

FIG. 4

2

Pull Memorial Chamber Lid outward until it pops off

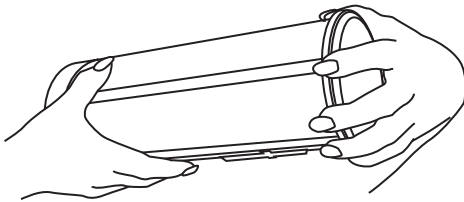

FIG. 2

5

Place Lid back on candle and press down firmly until it snaps into place

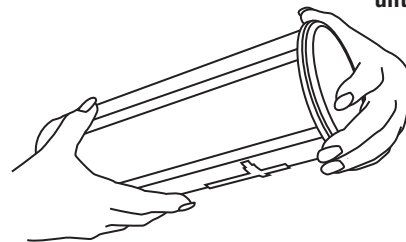

FIG. 5

3

Remove Lid to expose recessed Memorial Chamber

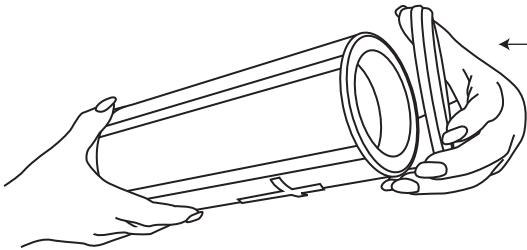
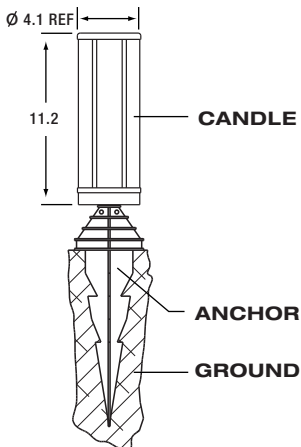

FIG. 3

OPTIONAL ACCESSORIES

GROUND ANCHOR



BATTERY ANTI-THEFT DEVICE

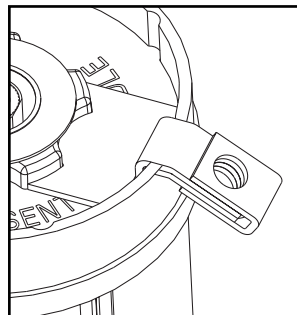

LIMITED WARRANTY

Smartlite™ warrants that this sentinel candle is free from defects in material and workmanship that result in product failure for ninety (90) days from the purchase of this product. This limited warranty extends only to the original purchaser. This warranty does not cover abused or misused product.

Smartlite™ will repair or replace at Smartlite's sole option any defective part or any part that will not operate properly.

In no event shall Smartlite™ be liable for any incidental or consequential damage arising from the sale or use of this product.

Upon request from Smartlite™, customer must prove date of original purchase by a dated itemized receipt.

Customer must pay shipping charges to our factory and Smartlite™ will return corrected product prepaid to customer.

All questions concerning warranty and shipping instructions on this product must be sent to:

SmartLite™

THE REALISTIC ELECTRONIC CANDLE

510 EAST 41ST ST PATERSON, NJ 07504
TEL 973.523.0668 FAX 973.523.0375

TOLL FREE 1.888.249.9039 X128

WWW.SMARTLITECH.COM